

### DESCRIPTION

The Warmup Speedfit-Box is a multiple-entry Power connection junction box for use with self-regulating cable. It can be mounted on conduit or against a wall for Roof & Gutter applications or secured to a pipe with the provided Pipe Mounting Bracket. This robust and corrosion-resistant polyamide enclosure can be supplied to replace "Power Connection Kits" and are safe for use in non-hazardous and hazardous (Class 1 Div. 2) environments. The Speedfit-Box provides EExe protection for "Electrical Apparatus for Potentially Explosive Atmospheres".

### FEATURES

The mounting bracket allows for up to two Self-Regulating cable entries from separate runs. Another opening in the box is designed for the power supply. Load and line meet in a safely mounted set of screw connectors on a rail inside the box. The enclosure can be easily accessed through the hinged cover secured with 4 screws (provided).

### SPECIFICATION

<b>OPERATING TEMPERATURES</b>	-40°F to +212°F / -40°C to +50°C
<b>MATERIAL</b>	Glass reinforced Polyester, Fire Retardant

### APPLICATIONS

- Self-regulating cable connections for Roof & Gutter De-Icing
- Self-Regulating cable connections for Pipe Freeze Protection
- Class 1 Division 2 certified for hazardous locations

### DIMENSIONS

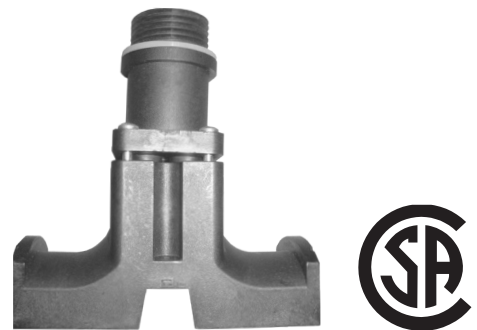
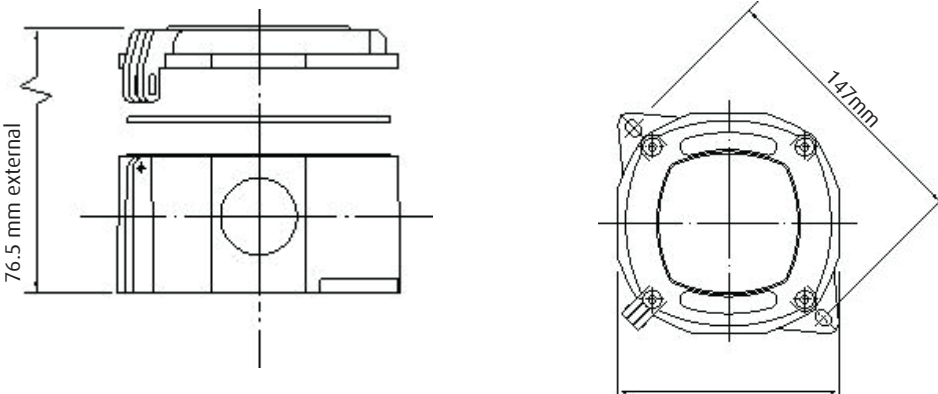

### INSTALLATION INSTRUCTIONS

1. After the seal fitting is open, put the junction box cap, strain relief disk, grommet, and body onto the power connection of cable.

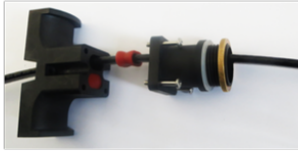

Figure 1

2. Slice completely around heating cable outer jacket, and then down a distance of 4.5" (119mm), being careful not to cut braid or inner jacket. Then, bend heating cable to break jacket where sliced, and peel off outer jacket



Figure 2

3. Carefully push braid back to loosen and spread apart as shown.



Figure 3

4. The heating cable must be bent as shown in Figure 8 so it can be pushed through the braid opening.



Figure 4

5. Place braid to one side of cable. Cut inner jacket of cable back 3.5" (90mm).



Figure 5

6. Shave off outer matrix material from conductors with utility knife. See Figure 6.



Figure 6

7. Peel back exposed wires from central matrix material. See Figure 7. Do not cut bus wire strands!

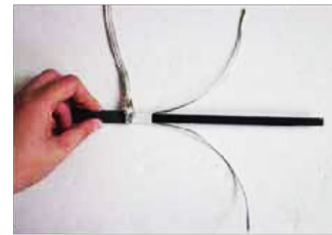

Figure 7

8. Cut off remaining center core of matrix; leaving the bare conductors. Do not cut bus wires!

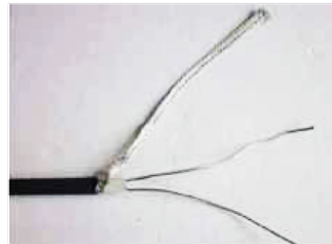

Figure 8

9. Slip on black shrink tubes 3" (77mm) in place up to conductive core.

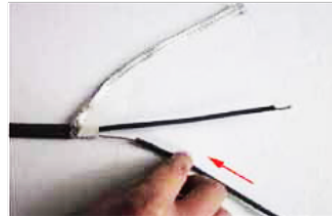

Figure 9

10. Carefully shrink tubing by moving heat source from side to side continuously; being careful not to damage heating cable.



Figure 10

11. Then, insert green/yellow tube over braid and shrink.



Figure 11

12. Center black shrink tube 1" (25mm) over end of heating cable as shown in Figure 12.



Figure 12

13. While tube is still hot, pinch tube with pliers, between wires, and hold for 10 seconds to ensure seal. See Figures 13.



Figure 13

14. For heating cables with an outer jacket, slide parts in place as shown below.

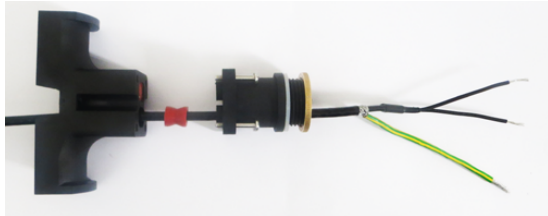

Figure 14-1



Figure 14-2

15. **power wire:** Cut inner jacket of cable back 3.9"(100mm),  
Cut Conductor wire 0.5"(12mm)

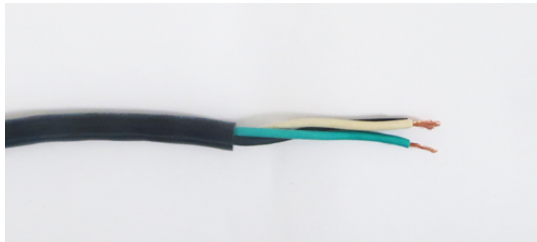

Figure 15

16. Connect the power conductors to the cable leads. Connect the incoming supply ground to the cable braid and to the green ground wire. The wire nuts, included, are not for use with aluminum feed wires. The junction box needs to be grounded.



Figure 16-1



Figure 16-2



Figure 16-3

### TECHNICAL SUPPORT

Warmup is available 24/7/365 at (888) 927-6333.

For quotes, layouts and specific technical information, contact us at:

#### Warmup USA

(888) 927-6333

us@warmup.com

#### Warmup CANADA

(888) 592-7687

ca@warmup.com

### RELATED PRODUCTS

- NAMSUR CABLE FOR ROOF & GUTTER APPLICATIONS - see WSC-0929
- NAMSUR CABLE FOR PIPE FREEZE PROTECTION - see WSC-0930
- SPEEDFIT SPLICE - see WSC-2804
- SPEEDFIT-TEE - see WSC-0105
- SPEEDFIT-END KIT - see WSC-3004